

FEATURES

- Presence Detector (PIR) with 2 adjustable-sensitivity sectors
- Detection length of up to 10m
- Lighting level sensor
- 6 presence detection channels
- Occupancy detection
- 10 logic functions
- Total data saving on KNX bus failure
- Integrated KNX BCU
- Dimensions 55.5 x 55.5 x 40mm
- Flush-mounted in back box with trim frame
- Conformity with the CE directives (CE-mark on the back side)

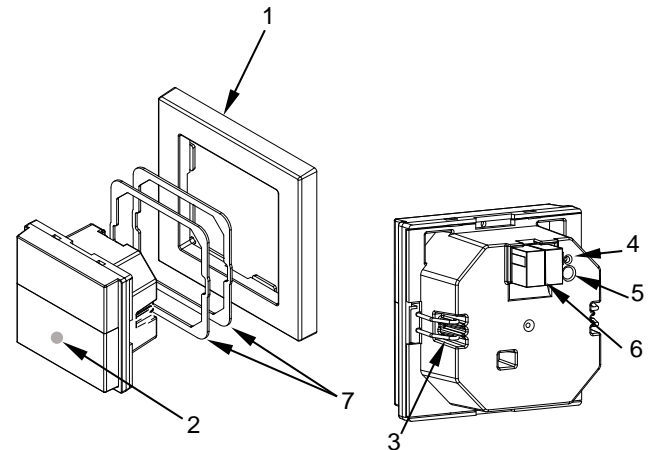

Figure 1: Presentia W0

1. Decorative frame*	2. Detection notification LED	3. Fixing clip
4. Programming LED	5. Programming button	6. KNX connector
		7. Levelling plates (1 and 1,5mm)

* Sold separately.

Programming button: short press to set programming mode. If this button is held while plugging the device into the KNX bus, it enters the safe mode.

Programming LED: programming mode indicator (red). When the device enters the safe mode, it blinks (red) every half second. During the start-up (reset or after KNX bus failure) and if the device is not in safe mode, it emits a red flash.

GENERAL SPECIFICATIONS				
CONCEPT		DESCRIPTION		
Type of device		Electric operation control device		
KNX supply	Voltage (typical)	29VDC SELV		
	Voltage range	21..31VDC		
	Maximum consumption	Voltage	mA	mW
		29VDC (typical)	5.3	153.7
24VDC ¹	10	240		
Connection type		Typical TP1 bus connector for 0.80mm Ø rigid cable		
External power supply		Not required		
Operation temperature		0°C .. +45°C ²		
Storage temperature		-20°C .. +55°C		
Operation humidity		5 .. 95%		
Storage humidity		5 .. 95%		
Complementary characteristics		Class B		
Protection class		III		
Operation type		Continuous operation		
Device action type		Type 1		
Electrical stress period		Long		
Degree of protection		IP20, clean environment		
Installation		Flush mount on back box		
Minimum clearances		Not required		
Response on KNX bus failure		Data saving according to parameterization		
Response on KNX bus restart		Data recovery according to parameterization		
Operation indicator		The programming LED indicates programming mode (red). The motion sensor initialization, after powering up the device, is indicated through the detection LED (red blinking). The motion detections are indicated by a red flash (in case the LED is enabled).		
Weight		71g		
PCB CTI index		175V		
Housing material		PC FR V2 halogen free housing and HDPE lens		

¹ Maximum consumption in the worst-case scenario (KNX Fan-In model).

² Temperatures over 35°C could decrease the detection range

INSTALLATION INSTRUCTIONS

1. Fix the metal plate into a square or round flush box using the screws from the box. Fit the device and the frame together. If necessary, insert the metallic levelling plate or plates (included) to ensure that the device has the desired depth.
2. Connect the KNX bus to the back of the device.
3. Fit the device and frame into their final position and check that the strength of the clips is enough to fix the device. **Avoid pressing on the lens during this step in order to prevent accidental damages to the device.** To uninstall proceed the reverse way.

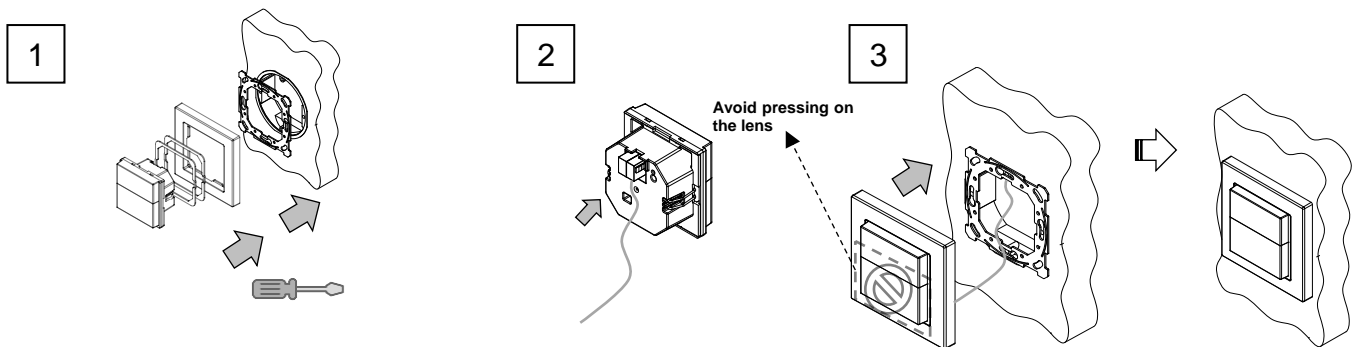

INSTALLATION ADVICES

1. Avoid the installation near high or low temperature air flow which can be provoked by HVAC equipment or heaters.
2. Visibility between sensor and people must not be blocked by objects or furniture. Most of transparent materials, such as glass, block the sensor visibility.
3. The detection sensitivity can get worse in the presence of great surfaces with high temperature, such as radiant floor.

PRESENCE DETECTOR FEATURES

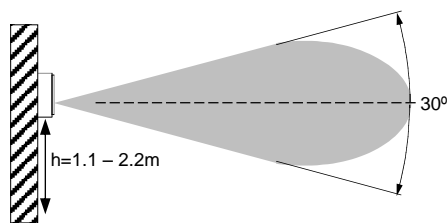

Figure 2: Detection angle (side view)

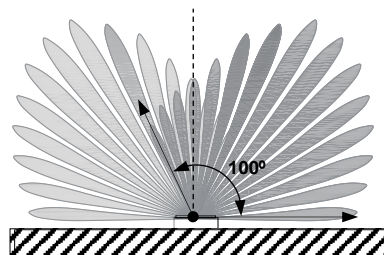
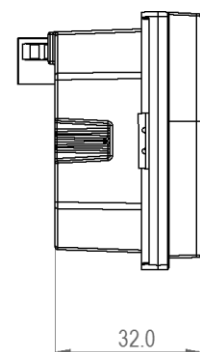
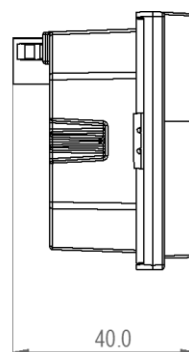
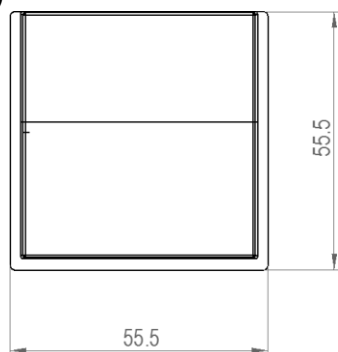

Figure 3: Detection sectors (upper view)

Maximum movement detection = 10m
 $h=1.1 - 2.2m$ and sensitivity = 100%
 For perpendicular movement to the sensor, the motion detection area is decreased (see external document: *installation tips*).

DIMENSIONS (MM)



SAFETY INSTRUCTIONS AND ADDITIONAL NOTES

- Installation should only be performed by qualified professionals according to the laws and regulations applicable in each country.
- Do not connect the mains voltage nor any other external voltage to any point of the KNX bus; it would represent a risk for the entire KNX system. The facility must have enough insulation between the mains (or auxiliary) voltage and the KNX bus or the wires of other accessories, in case of being installed.
- Keep the device away from water (condensation over the device included) and do not cover it with clothes, paper or any other material while in use.
- The WEEE logo means that this device contains electronic parts and it must be properly disposed of by following the instructions at <https://www.zennio.com/en/legal/wEEE-regulation>.
- This device contains software subject to specific licences. For details, please refer to <http://zennio.com/licenses>.