

FEATURES

- 320mA KNX power supply with 29VDC auxiliary output
- 110-240VAC 50/60Hz power input
- KNX system voltage supply and monitorization
- Short-circuit and overvoltage protection
- Reset button and overload status LED
- KNXnet/IP tunneling protocol (up to 5 connections)
- Maximum APDU length of 254bytes
- Ethernet 10/100 BaseT IP with RJ45 socket
- 2 different configurable blocks: shutter channels (up to 4), individual outputs (up to 8) and 2/4-pipe fan coil controls (up to 1)
- Outputs suitable for capacitive loads, maximum 140µF
- Manual output operation through remote control
- 8 analog/digital inputs
- Climate control for up to 4 rooms
- Output timing
- 20 logic functions
- Total data saving on KNX bus failure
- Integrated KNX BCU
- Dimensions 67 x 90 x 140 mm (8 DIN units)
- DIN rail mounting (EN 50022), with fixing clamp
- Possibility of connecting different phases in adjacent channels
- Conformity with the CE directives (CE-mark on the right side)

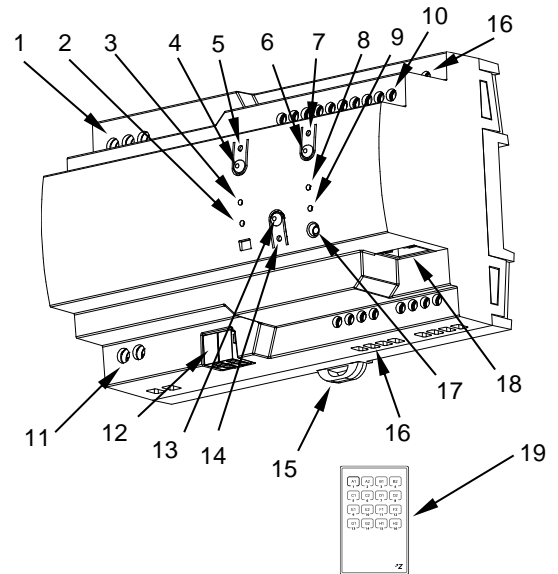

1. Main power supply	2. Overload status LED	3. Power supply status LED	4. Reset button	5. Reset status LED
6. IP factory reset button	7. IP factory reset LED	8. Ethernet LED	9. KNX bus LED	10. Analog/digital inputs
11. Auxiliary power output	12. KNX connector	13. Programming/Test button	14. Programming/Test LED	15. Fixing clamp
16. Outputs	17. IR input	18. Ethernet connector	19. Remote control (not included, ref. 9900024)	

PROGRAMMING/TEST BUTTON: short press to set programming mode. If this button is held while providing main power supply to the device, it enters the safe mode. If this button is held for more than 3 seconds, the device enters the test mode.

PROGRAMMING/TEST LED: programming mode indicator (red). When the device enters the safe mode, it blinks (red) every half second. The manual mode is indicated by the green color. During the start-up (reset or after providing main power supply) and if the device is not in safe mode, it starts a blue blinking sequence.

POWER SUPPLY STATUS LED: it indicates the status of the power supply (green color: the device is working properly; off LED: power supply failure; green blinking: short-circuit on KNX bus and/or auxiliary power output).

OVERLOAD STATUS LED: it indicates an overload on the KNX line or on the auxiliary power output (red blinking: cut-off due to overload/short circuit on the KNX bus and/or the auxiliary power output*; red color: overload on bus and/or auxiliary power output line *).

*Reduce the load on the bus and/or the auxiliary power output lines until its total consumption does not exceed the maximum current specified.

KNX BUS LED: it indicates that the device is powering up the KNX bus (green color).

ETHERNET LED: it indicates that the device is connected to Ethernet and has an IP address assigned (green color).

RESET INDICATOR LED: it indicates that a reset of the KNX system has been performed by using the corresponding reset button (red blinking). To reset the bus power supply, the Reset button should be pressed (it is recommended to hold it for at least 5 seconds to verify the reset of all the devices in the line). The reset LED will blink slightly in red while the Reset button is pressed.

IP FACTORY RESET INDICATOR LED: it indicates that the device has just performed an IP factory reset (red color). To reset the KNX IP Interface, the IP Factory reset button must be pressed for at least 3 seconds.

MANUAL CONTROL: In order to perform manual control of the device, an IR remote control is necessary (Ref. 9900024) not included with the ALLinBOX 88. When the device is in Test On mode, the manual control can be done by pressing the corresponding buttons on the IR remote control (please, be sure that the remote IR emitter is pointing to the IR input of ALLinBOX 88).

GENERAL SPECIFICATIONS		
CONCEPT		DESCRIPTION
Type of device		Electric operation control device
External power supply	Voltage	110-240VAC 50/60Hz
	Maximum consumption	250mA@110VAC / 125mA@230VAC
KNX supply	Voltage (typical)	29VDC SELV (with KNX coil)
	Maximum rated current (I _{BUS})	320mA
	Connection type	Typical TP1 bus connector for 0.80mm Ø rigid cable
Additional output	Voltage (typical)	29VDC SELV
	Maximum rated current (I _{AD})	I _{AD} + I _{BUS} ≤ 320mA
Operation temperature		-5°C .. +45°C
Storage temperature		-20°C .. +55°C
Operation humidity		5 .. 95%
Storage humidity		5 .. 95%
Complementary characteristics		Class B
Protection class / Overvoltage category		II / III (4000V)
Operation type		Continuous operation
Device action type		Type 1
Electrical stress period		Long
Degree of protection / Pollution degree		IP20 / 2 (clean environment)
Installation		Independent device to be mounted inside electrical panels with DIN rail (EN 50022)
Minimum clearances		Not required
Power failure back-up time		110ms
Maximum current before overload notification		500mA
Response on KNX bus failure		Data saving according to parameterization
Response on KNX bus restart		Data recovery according to parameterization
Operation indicator		See page 1
Weight		521g
PCB CTI index		175V
Housing material / Ball pressure test temperature		PC FR V0 halogen free / 75°C (housing) - 125°C (connectors)

MAIN POWER SUPPLY SPECIFICATIONS AND CONNECTIONS		
CONCEPT		DESCRIPTION
Power supply protection fuse	Voltage	110-240VAC 50/60Hz
	Current	6.3A
	Response type	F (Fast acting)
Connection method		Screw terminal block
Cable cross-section		1.5-4mm ² (IEC) / 26-10AWG (UL)

AUXILIARY POWER OUTPUT SPECIFICATIONS AND CONNECTIONS		
CONCEPT		DESCRIPTION
Connection method		Screw terminal block
Cable cross-section		1.5-4mm ² (IEC) / 26-10AWG (UL)

OUTPUTS SPECIFICATIONS AND CONNECTIONS		
CONCEPT		DESCRIPTION
Number of outputs		8
Output type / Disconnection type		Potential-free outputs through bistable relays with tungsten pre-contact / Micro-disconnection
Rated current per output		AC 16(6)A @ 250VAC (4000VA) DC 7A @ 30VDC (210W)
Maximum load per output	Resistive	4000W
	Inductive	1500VA
Maximum inrush current		800A/200µs 165A/20ms
Different phases connection		Possibility of connecting different phases. It is not allowed to connect power supplies of different order, SELV with NO SELV, in the same block
Maximum current per block		40A
Maximum current per channel		16A
Short-circuit protection		NO
Overload protection		NO
Over-voltage protection		NO
Connection method		Screw terminal block
Cable cross-section		0.5-2.5mm ² (IEC) / 26-12AWG (UL)
Outputs per common		2
Maximum response time		10ms
Mechanical lifetime (min. cycles)		3 000 000
Electrical lifetime (min. cycles) ¹		100000 @ 8A / 25000 @ 16A (VAC)

¹ Lifetime values could change depending on the load type.

WIRING DIAGRAMS

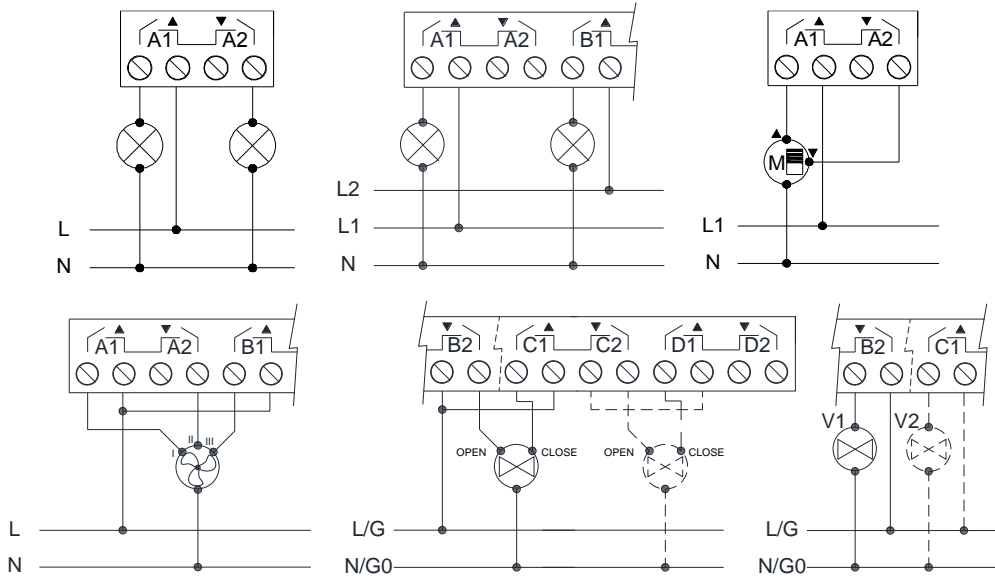

⚠ In order to ensure the expected status of the relays, please check that the device is connected to the main power supply before energizing the power circuit.

For a 4-pipe fan coil, the cooling valve should always be connected on the left side and the heating valve on the right side. Before the start-up of the device, it must be assured that the valve is completely closed.

The fan and the valves to be connected must have the same nominal supply voltage.

Outputs that are not being used for valve control can be used as individual outputs or shutter channels.

Figure 1: Wiring example (from top to bottom and left to right): 2 loads, 2 loads connected to different phases, shutter channel, fan coil three-speed fan, fan coil three-point valves and fan coil open/close valves.

INPUTS SPECIFICATIONS AND CONNECTIONS

CONCEPT	DESCRIPTION
Number of inputs	8
Inputs per common	4
Operation voltage	+3.3VDC in the common
Operation current	1mA @ 3.3VDC (per input)
Switching type	Dry voltage contacts between input and common
Connection method	Screw terminal block
Cable cross-section	0.5-2.5mm ² (IEC) / 26-12AWG (UL)
Maximum cable length	30m
NTC probe length	1.5m (extensible up to 30m)
NTC accuracy (@ 25°C) ²	±0.5°C
Temperature resolution	0.1°C
Maximum response time	10ms

² For Zennio temperature probes.

INPUTS CONNECTION

Any combination of the following **accessories** is allowed in the inputs:

Temperature Probe**

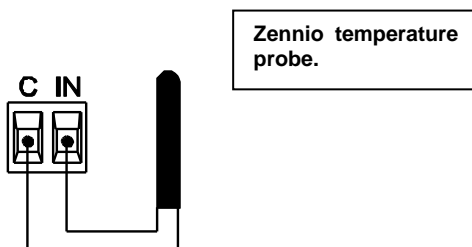

Motion Sensor

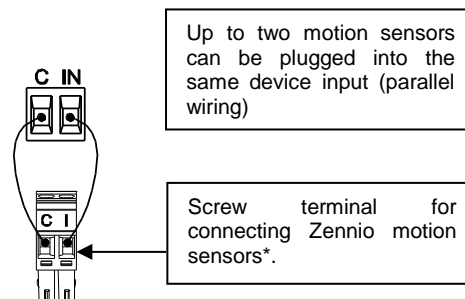

Switch/Sensor/ Push button

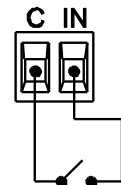

* In case of using ZN110-DETEC-P sensor, its micro switch number 2 must be in **Type B position**.

** Zennio temperature probe or any NTC with known resistance values at three points in the range [-55, 150°C].

INSTALLATION AND CONNECTION

- This device must be exclusively installed in a 35mm DIN rail inside a distribution box or an electrical panel.
- Ensure suitable ventilation to prevent the temperature from exceeding the permissible range.
- Main power must be connected to L, N and ground terminals.
- The coil integrated bus output must be connected through a standard KNX connector.
- The additional output connection must be connected according to the polarity indicated on the housing.

Attaching ALLinBOX 88 to DIN rail:

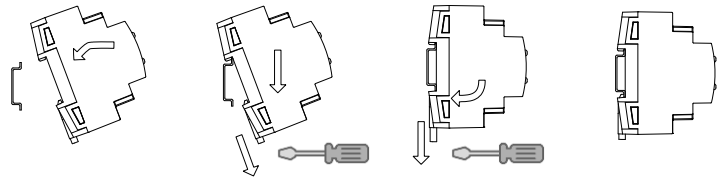

Removing ALLinBOX 88 from DIN rail:

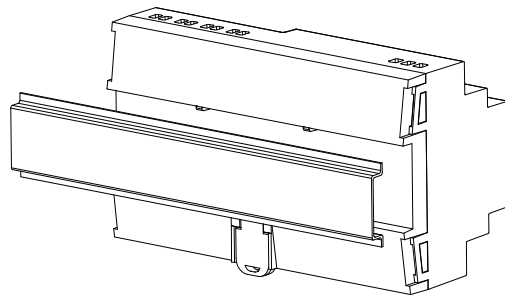
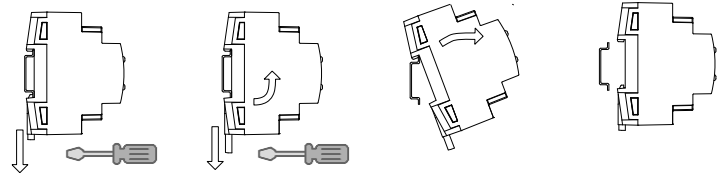

Figure 2: Mounting ALLinBOX 88 on DIN rail



SAFETY INSTRUCTIONS AND ADDITIONAL NOTES

- Installation should only be performed by qualified professionals according to the laws and regulations applicable in each country.
- Do not connect the mains voltage nor any other external voltage to any point of the KNX bus; it would represent a risk for the entire KNX system. The facility must have enough insulation between the mains (or auxiliary) voltage and the KNX bus or the wires of other accessories, in case of being installed.
- The facility must be equipped with a device that ensures the omnipolar sectioning. Installation of a 10A mini-circuit-breaker is recommended. To prevent accidents, it must remain open in case of manipulation of the device.
- The device has a short-circuit protection fuse that, in case of activation, should only be rearmed or replaced by the Zennio technical service.
- This device contains a security short-circuit proof transformer.
- Once the device is installed (in the panel or box), it must not be accessible from outside.
- For indoor use only
- Keep the device away from water (condensation over the device included) and do not cover it with clothes, paper or any other material while in use.
- The WEEE logo means that this device contains electronic parts and it must be properly disposed of by following the instructions at <https://www.zennio.com/en/legal/weee-regulation>.
- This device contains software subject to specific licences. For details, please refer to <http://zennio.com/licenses>.

