

FEATURES

- KNX power supply 640mA with additional output 29VDC.
- Nominal output current: 640mA (KNX bus plus additional output consumption).
- External 230VAC 50/60Hz power supply.
- ZPS640HIC230 power supply generates and monitors the KNX system voltage supply.
- Short-circuit and overload protection.
- Reset button and overload status LED.
- KNX coil included.
- Dimensions 67 x 90 x 79mm (4.5 DIN units).
- DIN rail mounting (EN 50022), through pressure.
- Conformity with the CE directives (CE-mark on the right side).

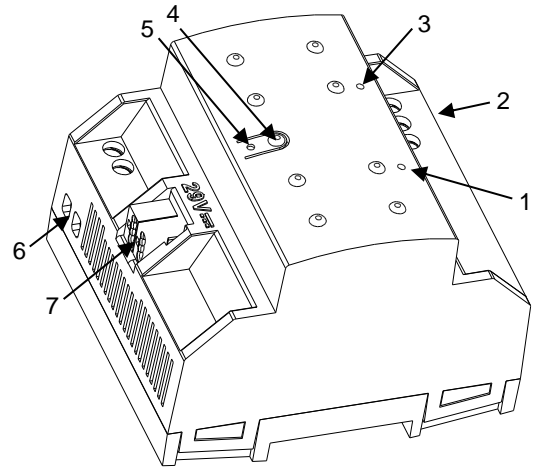

Figure 1: ZPS640HIC230 power supply

- | | | | |
|-----------------|----------------------|------------------|-----------------|
| 1. Overload LED | 2. Main power | 3. Power LED | 4. Reset button |
| 5. Reset LED | 6. Additional output | 7. KNX connector | |

GENERAL SPECIFICATIONS

CONCEPT	DESCRIPTION	
Type of device	Electric operation control device	
External power supply	Voltage	220-240VAC 50/60Hz
	Maximal consumption	250mA
KNX supply	Voltage (typical)	29VDC SELV (KNX coil included)
	Nominal output current (I _{BUS})	640mA
	Connection type	Typical TP1 bus connector for rigid cable 0.80mm Ø
Additional output	Voltage (typical)	29VDC SELV
	Nominal output current (I _{ADD})	I _{ADD} + I _{BUS} ≤ 640mA
Operation temperature	-5°C to +55°C	
Storage temperature	-20°C to +55°C	
Operation humidity	5 to 95% RH (no condensation)	
Storage humidity	5 to 95% RH (no condensation)	
Complementary characteristics	Class B	
Protection class	I	
Operation type	Continuous operation	
Device action type	Type 1	
Electrical stress period	Long	
Degree of protection	IP20, clean environment	
Installation	Independent device to be mounted inside electrical panels with DIN rail (EN 50022)	
Minimum clearances	Not required	
Power failure back-up time	130ms	
Maximal current before overload notification	850mA	
Operation indicator	Please, see "CONTROLS AND INDICATORS" chapter.	
Weight	247g	
PCB CTI index	175V	
Housing material	PC FR V0 halogen free	

EXTERNAL POWER SUPPLY SPECIFICATIONS AND CONNECTIONS		
CONCEPT		DESCRIPTION
Power supply protection fuse	Voltage	250V
	Current	4A
	Response type	F (Fast acting)
Connection method		Screw terminal block
Cable cross-section		0.5mm ² to 4mm ² (26-10AWG)

ADDITIONAL OUTPUT SPECIFICATIONS AND CONNECTIONS		
CONCEPT		DESCRIPTION
Connection method		Screw terminal block
Cable cross-section		0.5mm ² to 4mm ² (26-10AWG)

INSTALLATION AND CONNECTION

- This KNX power supply must be exclusively installed in a 35mm DIN rail inside a distribution box or an electrical panel.
- Ensure suitable ventilation to prevent the range of the permissible temperatures from being exceeded.
- Main power must be connected to L, N and ground terminals, in accordance with the schematic represented in figure 2.
- The coil integrated bus output must be connected through a standard KNX connector.
- The additional output connection must be connected according to the polarity indicated on the housing.

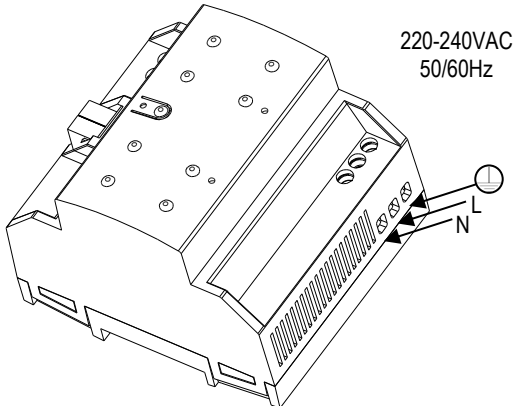

Figure 2: ZPS640HIC230 installation and connection

CONTROLS AND INDICATORS

Power LED indicates the status of the device :

- LED ON (green): the device is working properly.
- LED OFF: input voltage failure.
- LED blinking (green): KNX bus and/or additional output short-circuit.

Overload LED indicates if the maximum current specified is exceeded:

- LED OFF: maximum current specified is not exceeded.
- LED blinking (red): switch off due to overload/shortcircuit in the KNX bus and/or the additional output*.
- LED ON (red): bus and/or additional output line overload*.

*Reduce the load on the bus and/or the additional output lines until its total consumption does not exceed the maximum current specified.

Note: To reset the bus power supply, the Reset button should be pressed (it is recommended to hold it for at least 5 seconds to verify the reset of all the devices in the line). The Reset LED will blink slightly in red while the Reset button is pressed.

Note 2: two power supply units may work in parallel as long as none of them shows overload. In such case, the position on the KNX bus should be modified until the error disappears.

SAFETY INSTRUCTIONS

- Installation should only be performed by qualified professionals according to the laws and regulations applicable in each country.
- Do not connect the mains voltage nor any other external voltage to any point of the KNX bus; it would represent a risk for the entire KNX system. The facility must have enough insulation between the mains (or auxiliary) voltage and the KNX bus or the wires of other accessories, in case of being installed.
- The facility must be equipped with a device that ensures the omnipolar sectioning. Installation of a 10A mini-circuit-breaker is recommended. To prevent accidents, it must remain open in case of manipulation of the device.
- The device has a short-circuit protection fuse that, in case of activation, should only be rearmed or replaced by the Zennio technical service.
- This device contains a security short-circuit proof transformer.
- Once the device is installed (in the panel or box), it must not be accessible from outside.
- For indoor use only.
- Keep the device away from water and do not cover it with clothes, paper or any other material while in use.
- The WEEE logo means that this device contains electronic parts and it must be properly disposed of by following the instructions at <http://zennio.com/weee-regulation>.