

FEATURES

- Power and energy estimation: up to 3 circuits
- Water consumption estimation: up to 4 channels
- Estimation of heat consumption: up to 2 energy modules
- 3 registers for data storage
- Possibility of synchronizing to a KNX system clock
- 5 analog/digital inputs
- 10 logic functions
- Total data saving on KNX bus failure
- Integrated KNX BCU
- Dimensions 67 x 90 x 79mm (4.5 DIN units)
- DIN rail mounting according to IEC 60715 TH35, with fixing clamp
- Conformity with the CE directives (CE-mark on the right side)

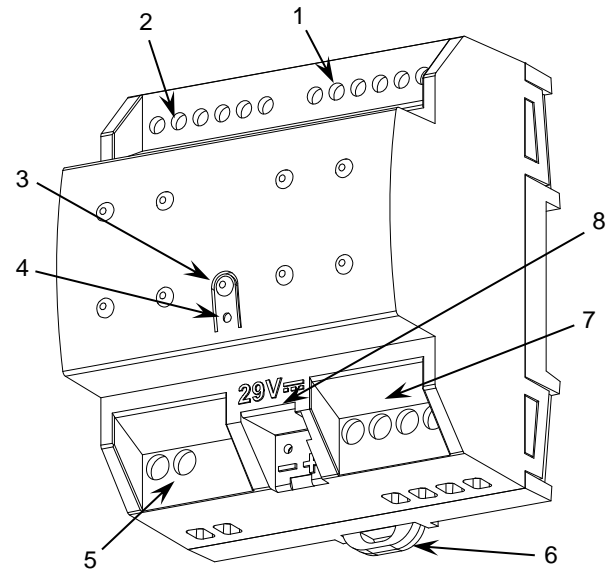

Figure 1: KEM

1. Analog/digital inputs	2. Current transformer connections	3. Programming button	4. Programming LED
5. Flow sensor power output	6. Fixing clamp	7. Flow meter sensor inputs	8. KNX connector

Programming button: short press to set programming mode. If this button is held while plugging the device into the KNX bus, it enters the safe mode.

Programming LED: programming mode indicator (red). When the device enters the safe mode, it blinks (red) every half second. During the start-up (reset or after KNX bus failure) and if the device is not in safe mode, it emits a red flash.

GENERAL SPECIFICATIONS

CONCEPT		DESCRIPTION		
Type of device		Electric operation control device		
KNX supply	Voltage (typical)	29VDC SELV		
	Voltage range	21..31VDC		
	Maximum consumption	Voltage	mA	mW
		29VDC (typical)	23	667
24VDC ¹	30	720		
Connection type		Typical TP1 bus connector for 0.80mm Ø rigid cable		
External power supply		Not required		
Operation temperature		0°C .. +55°C		
Storage temperature		-20°C .. +55°C		
Operation humidity		5 .. 95%		
Storage humidity		5 .. 95%		
Complementary characteristics		Class B		
Protection class		III		
Operation type		Continuous operation		
Device action type		Type 1		
Electrical stress period		Long		
Degree of protection		IP20, clean environment		
Installation		Independent device to be mounted inside electrical panels with DIN rail (IEC 60715)		
Minimum clearances		Not required		
Response on KNX bus failure		Data saving according to parameterization		
Response on KNX bus restart		Data recovery according to parameterization		
Operation indicator		The programming LED indicates programming mode (red).		
Weight		158g		
PCB CTI index		175V		
Housing material		PC FR V0 halogen free		

¹ Maximum consumption in the worst-case scenario (KNX Fan-In model).

CURRENT PROBE SPECIFICATIONS AND CONNECTIONS	
CONCEPT	DESCRIPTION
Number of phases or lines	3
Measurement method	Current transformer (Np:Ns=1:3000)
Zennio Current Transformer (Accessory reference)	ZN1AC-CST60
Measurement range	20mA-20A
Accuracy ¹	5%
Connection method	Screw terminal block
Cable cross-section	0.5-2.5mm ² (IEC) / 26-12AWG (UL)

¹ Maximum accuracy value on active power with Zennio current transformers. Accuracy may vary depending on the connected load and the power factor entered by parameter. Other current transformers are allowed as long as they meet the same characteristics as the Zennio transformers and comply with the IEC 61010-X safety standards.

FLOW METERS SPECIFICATIONS AND CONNECTIONS	
CONCEPT	DESCRIPTION
Flow meter type / Voltage	Turbine with Hall sensor / 5VDC
Maximum consumption	15mA
Zennio Flow Meter (Accessory reference)	½": 9900027 ¾": 9900028
Connection method	Screw terminal block
Maximum cable length	30m
Cable cross-section	1.5-4mm ² (IEC) / 26-10AWG (UL)

INPUTS SPECIFICATIONS AND CONNECTIONS	
CONCEPT	DESCRIPTION
Number of inputs	5
Inputs per common	5
Operation voltage	+3.3VDC in the common
Operation current	1mA @ 3.3VDC (per input)
Switching type	Dry voltage contacts between input and common
Connection method	Screw terminal block
Cable cross-section	0.5-2.5mm ² (IEC)/26-12AWG (UL)
Maximum cable length	30m
NTC probe length	0.5m (extensible up to 30m)
NTC accuracy (@ 25°C) ³	±0.5°C
Temperature resolution	0.1°C
Maximum response time	10ms

³ For Zennio temperature probes.

INPUTS CONNECTION

Any combination of the following accessories is allowed in the inputs:

Temperature Probe**

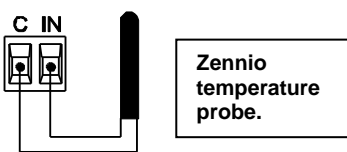

Motion Sensor

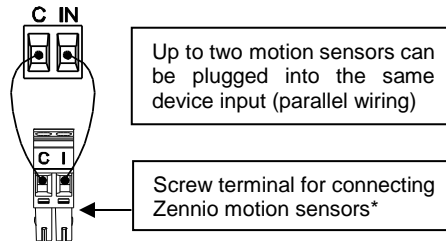

Switch/Sensor/ Push button

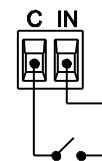

⚠ Commons of different devices must not be connected together.

* In case of using ZN1IO-DETEC-P sensor, its micro switch number 2 must be in **Type B position**.

** Zennio temperature probe or any NTC with known resistance values at three points in the range [-55, 150°C].

WIRING DIAGRAMS

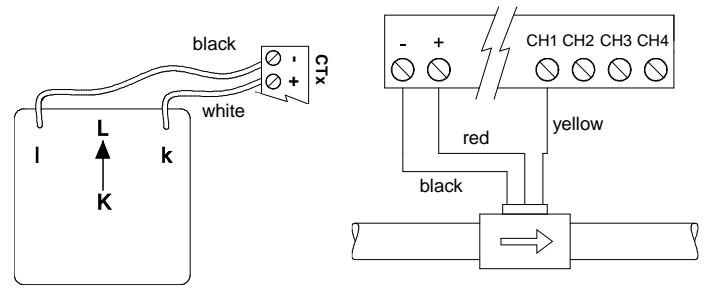
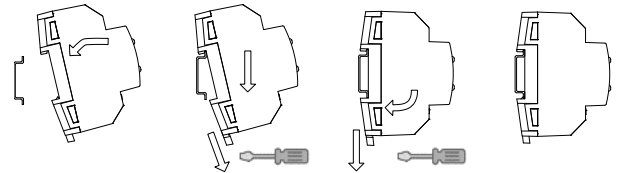

Figure 2: Wiring diagram (from left to right): Current transformer, hall-sensor flow meter.

⚠ **Note:** although other models can be parameterised, the flow meter function is only guaranteed for the water flow sensors provided by Zennio.

Attaching KEM to DIN rail:



Removing KEM from DIN rail:

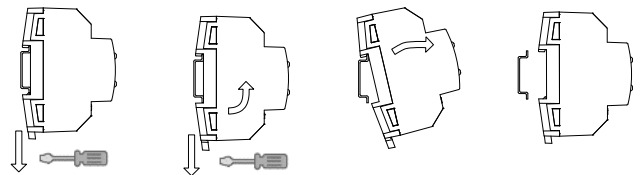

SAFETY INSTRUCTIONS AND ADDITIONAL NOTES

- Installation should only be performed by qualified professionals according to the laws and regulations applicable in each country.
- Do not connect the mains voltage nor any other external voltage to any point of the KNX bus; it would represent a risk for the entire KNX system. The facility must have enough insulation between the mains (or auxiliary) voltage and the KNX bus or the wires of other accessories, in case of being installed.
- Once the device is installed (in the panel or box), it must not be accessible from outside.
- Keep the device away from water (condensation over the device included) and do not cover it with clothes, paper or any other material while in use.
- The WEEE logo means that this device contains electronic parts and it must be properly disposed of by following the instructions at <https://www.zennio.com/en/legal/weee-regulation>.
- This device contains software subject to specific licences. For details, please refer to <http://zennio.com/licenses>.